



MAX9390 Evaluation Kit

General Description

The MAX9390 evaluation kit (EV kit) is a fully assembled and tested printed-circuit board (PCB) that simplifies the evaluation of the MAX9390 1.5GHz, dual 2 x 2 crosspoint switch. The EV kit accepts low-voltage differential signals (LVDS) or high-speed transistor logic (HSTL) input signals and converts the signals to LVDS outputs for each channel.

The MAX9390 EV kit is designed with 100Ω differential controlled impedance in a four-layer PCB. The board is designed for direct differential probing of the LVDS inputs/outputs. The EV kit operates from a single 3.3V supply. The MAX9390 EV kit can also be used to evaluate the MAX9391, which accepts LVPECL and CML input signals.

Features

- ◆ Single 3V to 3.6V Supply Operation
- ◆ 1.5GHz Operation
- ◆ 100Ω Controlled-Differential Signal Traces
- ◆ Supports Testing with Various Mediums
 - Differential Probes
 - Twisted-Pair Wire
 - Coax Cables with SMA Connectors
- ◆ Surface-Mount Components
- ◆ Fully Assembled and Tested

Ordering Information

PART	TYPE
MAX9390EVKIT+	EV Kit

+Denotes lead-free and RoHS-compliant.

Component List

DESIGNATION	QTY	DESCRIPTION
C1	1	10μF ±10%, 6.3V X5R ceramic capacitor (0805) Murata GRM21BR60J106K
C2	1	1μF ±10%, 6.3V X5R ceramic capacitor (0805) Murata GRM21BR60J105K
C3, C5, C8, C10–C18	12	0.1μF ±10%, 16V X5R ceramic capacitors (0603) Murata GRM188R61C104K
C4, C6, C7, C9	4	0.01μF ±10%, 50V X5R ceramic capacitors (0603) Murata GRM188R61H103K
C19	0	Not installed, capacitor (0805)
INA0, INA0, INA1 INA1, INB0, INB0 INB1, INB1, OUTA0, OUTA0, OUTA1, OUTA1, OUTB0, OUTB0, OUTB1, OUTB1	16	SMA connectors (edge mounted)

DESIGNATION	QTY	DESCRIPTION
J1–J8, JU1–JU9	17	2-pin headers
R1	0	Not installed, resistor (1206)
R2	0	Not installed, potentiometer Bourne 3361P-1-101GLF
R3–R10	8	49.9Ω ±1% resistors (0603)
R11–R18	0	Not installed, resistors (0603)
U1	1	Dual 2 x 2 crosspoint switch (32-pin TQFP, 5mm x 5mm x 1mm) Maxim MAX9390EHJ+
—	9	Shunts (JU1–JU9)
—	1	PCB: MAX9390 Evaluation Kit+

Component Supplier

SUPPLIER	PHONE	WEBSITE
Murata Mfg. Co., Ltd.	770-436-1300	www.murata.com

Note: Indicate that you are using the MAX9390 or MAX9391 when contacting this component supplier.

MAX9390 Evaluation Kit

Quick Start

Required Equipment

Before beginning, the following equipment is needed:

- 3V to 3.6V, 500mA power supply (VCC)
- LVDS signal generator (e.g., HP 8133A)
- Digital sampling oscilloscope or communication analyzer (e.g., CSA8000)

Procedure

The MAX9390 EV kit is fully assembled and tested. Follow the steps below to verify board operation.

Caution: Do not turn on the power supply until all connections are completed.

- 1) Connect the power supply to the VCC PCB pad. Connect the ground terminal of the power supply to GND PCB pad.
- 2) Set the signal generators to provide an LVDS signal (this requires both a noninverting and inverting signal output from the signal generator).
- 3) Verify that a shunt is not installed at jumper JU1 (MAX9390 evaluation).
- 4) Verify that shunts are installed at jumpers JU2, JU3, JU6, and JU7 (all outputs enabled).
- 5) Verify that a shunt is not installed across jumper JU4 and a shunt is installed across jumper JU5 (channel A configured in dual repeater mode).
- 6) Verify that a shunt is not installed across jumper JU8 and a shunt is installed across jumper JU9 (channel B configured in dual repeater mode).
- 7) Connect the signal generator's noninverting signals to the INA_ and INB_ SMA inputs.
- 8) Connect the signal generator's inverting signals to the INA_ and INB_ SMA inputs.
- 9) Connect all the OUT_ SMA output connectors to the digital oscilloscope inputs using 50Ω impedance cables.
- 10) Enable the signal generators' outputs.
- 11) Verify the signals by observing oscilloscope channels.

Detailed Description of Hardware

The MAX9390 EV kit is a fully assembled and tested PCB that simplifies the evaluation of the MAX9390 1.5GHz, dual 2 x 2 crosspoint switch. The EV kit accepts LVDS and HSTL signals at each input and converts the signals to LVDS output for each channel. The MAX9390 EV kit is designed with 100Ω differential controlled impedance in a four-layer PCB. The board is

designed for direct differential probing at the LVDS inputs/outputs and single-ended probing at the outputs using the respective 2-pin headers. The EV kit operates from a single 3.3V supply that provides 150mA of output current.

The MAX9390 EV kit consists of two independent LVDS channels (A and B) that can be configured to operate in one of three modes (crosspoint switch, 1:2 splitter, or dual repeaters), using on-board jumpers. All differential receiver inputs (IN_) are terminated with two series-connected 49.9Ω resistors. Resistor PCB pads R11–R18 are provided at the EV kit output channels for application-dependent termination.

Power Supply

The MAX9390 EV kit can utilize up to three power supplies. VCC is used as the power source for the MAX9390 and the logic inputs. VTERM_IN and VTERM_OUT are used as input- and output-termination voltages when evaluating the MAX9391. VTERM_IN has a 0 to VCC - 1.2V input supply voltage range. VTERM_OUT should be set to the respective LVDS common-mode or bias voltage.

Input Signals

The MAX9390 accepts LVDS or HSTL differential input signals. The differential high threshold is +100mV and the differential low threshold is -100mV. The SMA input connectors for the circuit are labeled INA_, INB_ (non-inverting) and $\overline{\text{INA}}_$, $\overline{\text{INB}}_$ (inverting). All differential inputs are terminated with two 49.9Ω resistors (R3–R10) to create a 100Ω impedance termination. The input signals can be monitored with a differential signal probe placed across header pins J1–J4 for the desired signal.

Output Signals

The four differential outputs can be accessed at header pins J5–J8 with shielded twisted-pair cables or differential probes. Pin 1 is the inverting signal ($\overline{\text{OUT}}_$) and Pin 2 is the noninverting signal (OUT_). When testing the EV kit using differential probes or twisted pairs, populate resistor PCB pads R11–R18 with 49.9Ω (0603) surface-mount resistors. In addition to populating resistors R11–R18, terminate the twisted-wire pair with a 100Ω resistor at the far end of the wire. All differential output pairs are laid out with equal trace length having a maximum length difference of 10 mils and 100Ω controlled differential-impedance traces.

Leave coupling capacitors C11–C18 in series with the outputs (OUT_, $\overline{\text{OUT}}_$) and resistor PCB pads R11–R18 unpopulated when interfacing the output SMA OUT_ connectors to 50Ω impedance oscilloscope inputs.

MAX9390 Evaluation Kit

Evaluates: MAX9390/MAX9391

Output Enable/Disable (JU2, JU3, JU6, JU7)

Jumpers JU2, JU3, JU6, and JU7 enable and disable the EV kit's corresponding outputs. Remove the shunts from the jumpers to disable the output pairs. The differential output pairs assert to a differential low condition when disabled. Install a shunt across the jumpers to enable the outputs. The outputs can also be enabled or disabled by applying a logic signal at pin 1 of jumpers JU2, JU3, JU6, and JU7. See Table 1 for proper jumper settings for enabling and disabling the corresponding outputs.

Switch Configuration (JU4, JU5, JU8, JU9)

Jumpers JU4 and JU5 control the signal routing for channel A differential inputs (INA0/INA0 and INA1/INA1). Jumpers JU8 and JU9 control the signal routing for channel B inputs (INB0/INB0 and INB1/INB1). Channels A and B can be configured as a 2 x 2 crosspoint switch, 1:2 splitter, or as dual repeaters by configuring these jumpers. See Tables 2 and 3 for proper jumper settings for the different switch configuration.

Table 1. Enabled/Disable Control (JU2, JU3, JU6, JU7)

JUMPER	SHUNT POSITION	OUTPUT STATUS
JU2	Not installed	OUTA1, $\overline{\text{OUTA1}}$ disabled
	Installed	OUTA1, $\overline{\text{OUTA1}}$ enabled
JU3	Not installed	OUTA0, $\overline{\text{OUTA0}}$ disabled
	Installed	OUTA0, $\overline{\text{OUTA0}}$ enabled
JU6	Not installed	OUTB1, $\overline{\text{OUTB1}}$ disabled
	Installed	OUTB1, $\overline{\text{OUTB1}}$ enabled
JU7	Not installed	OUTB0, $\overline{\text{OUTB0}}$ disabled
	Installed	OUTB0, $\overline{\text{OUTB0}}$ enabled

Table 2. Channel A Output Routing Configuration (JU4, JU5)

SHUNT POSITION		SWITCH CONFIGURATION	INPUT SIGNALS	OUTPUT SIGNALS
JU4	JU5			
Not installed	Not installed	1:2 splitter	INA0/ $\overline{\text{INA0}}$	OUTA0/ $\overline{\text{OUTA0}}$, OUTA1/ $\overline{\text{OUTA1}}$
Not installed	Installed	Dual repeaters	INA0/ $\overline{\text{INA0}}$	OUTA0/ $\overline{\text{OUTA0}}$
			INA1/ $\overline{\text{INA1}}$	OUTA1/ $\overline{\text{OUTA1}}$
Installed	Not installed	2 x 2 switch	INA0/ $\overline{\text{INA0}}$	OUTA1/ $\overline{\text{OUTA1}}$
			INA1/ $\overline{\text{INA1}}$	OUTA0/ $\overline{\text{OUTA0}}$
Installed	Installed	1:2 splitter	INA1/ $\overline{\text{INA1}}$	OUTA0/ $\overline{\text{OUTA0}}$, OUTA1/ $\overline{\text{OUTA1}}$

Table 3. Channel B Output Routing Configuration (JU8, JU9)

SHUNT POSITION		SWITCH CONFIGURATION	INPUT SIGNALS	OUTPUT SIGNALS
JU8	JU9			
Not installed	Not installed	1:2 splitter	INB0/ $\overline{\text{INB0}}$	OUTB0/ $\overline{\text{OUTB0}}$, OUTB1/ $\overline{\text{OUTB1}}$
Not installed	Installed	Dual repeaters	INB0/ $\overline{\text{INB0}}$	OUTB0/ $\overline{\text{OUTB0}}$
			INB1/ $\overline{\text{INB1}}$	OUTB1/ $\overline{\text{OUTB1}}$
Installed	Not installed	2 x 2 switch	INB0/ $\overline{\text{INB0}}$	OUTB1/ $\overline{\text{OUTB1}}$
			INB1/ $\overline{\text{INB1}}$	OUTB0/ $\overline{\text{OUTB0}}$
Installed	Installed	1:2 splitter	INB1/ $\overline{\text{INB1}}$	OUTB0/ $\overline{\text{OUTB0}}$, OUTB1/ $\overline{\text{OUTB1}}$

MAX9390 Evaluation Kit

Evaluating the MAX9391

The MAX9390 EV kit can be used to evaluate the MAX9391 by replacing U1 with the MAX9391. Install a shunt across jumper JU1, a resistor at R1, and a potentiometer at R2, in addition to applying the desired termination voltage at the VTERM_IN PCB pad to evaluate the MAX9391. Resistor R1 and potentiometer R2 are used to provide current sinking capability to the EV kit circuit when evaluating LVPECL, CML, and other VCC referenced differential input signals. PCB pad

VTERM_OUT can also be used to set the LVDS output termination voltages. See Table 4 for proper configuration of jumper JU1 when evaluating the MAX9391.

Table 4. Jumper JU1 Configuration

SHUNT POSITION	EVALUATES
Not installed	MAX9390
Installed	MAX9391

MAX9390 Evaluation Kit

Evaluates: MAX9390/MAX9391

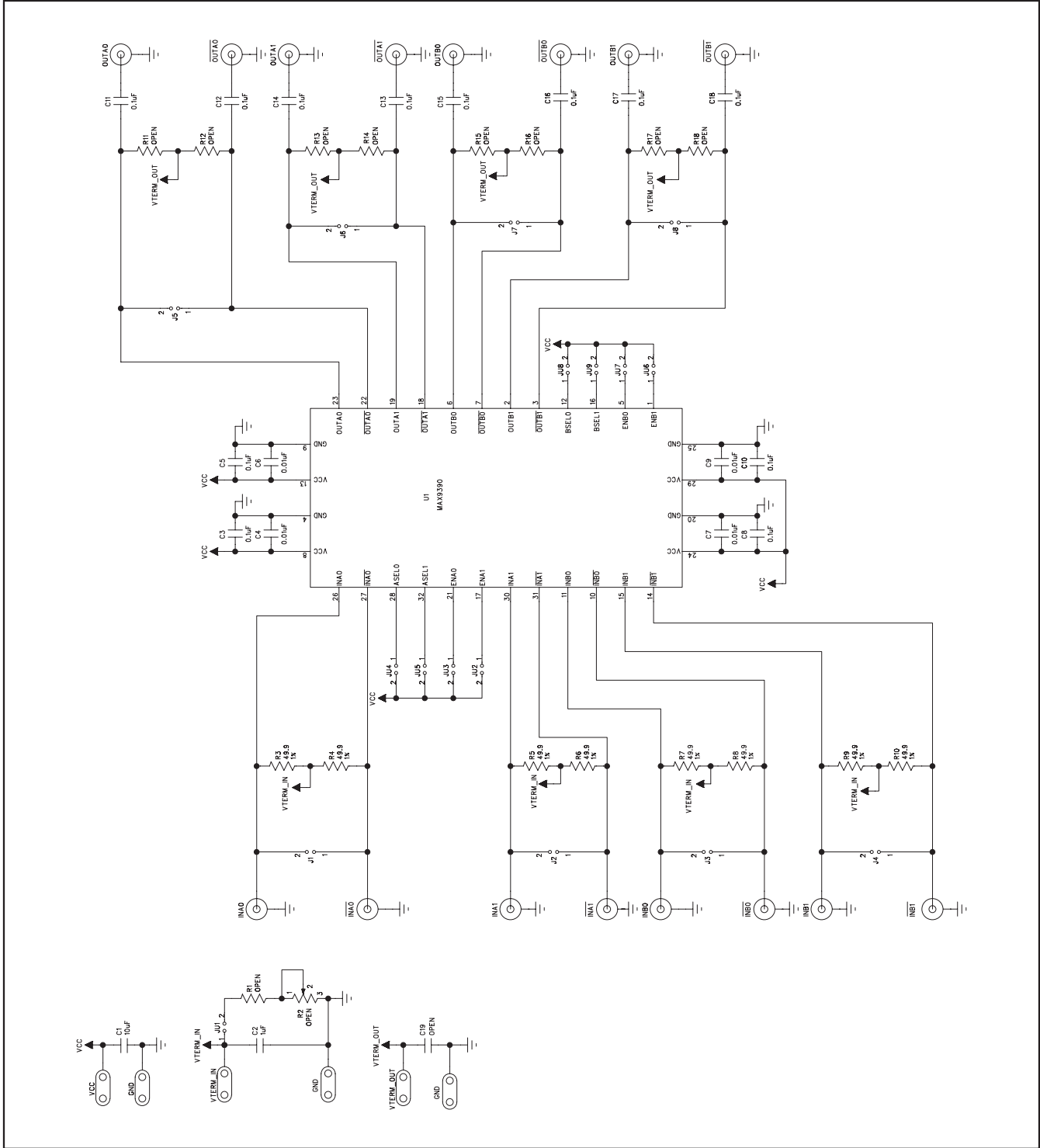

Figure 1. MAX9390 EV Kit Schematic

MAX9390 Evaluation Kit

Evaluates: MAX9390/MAX9391

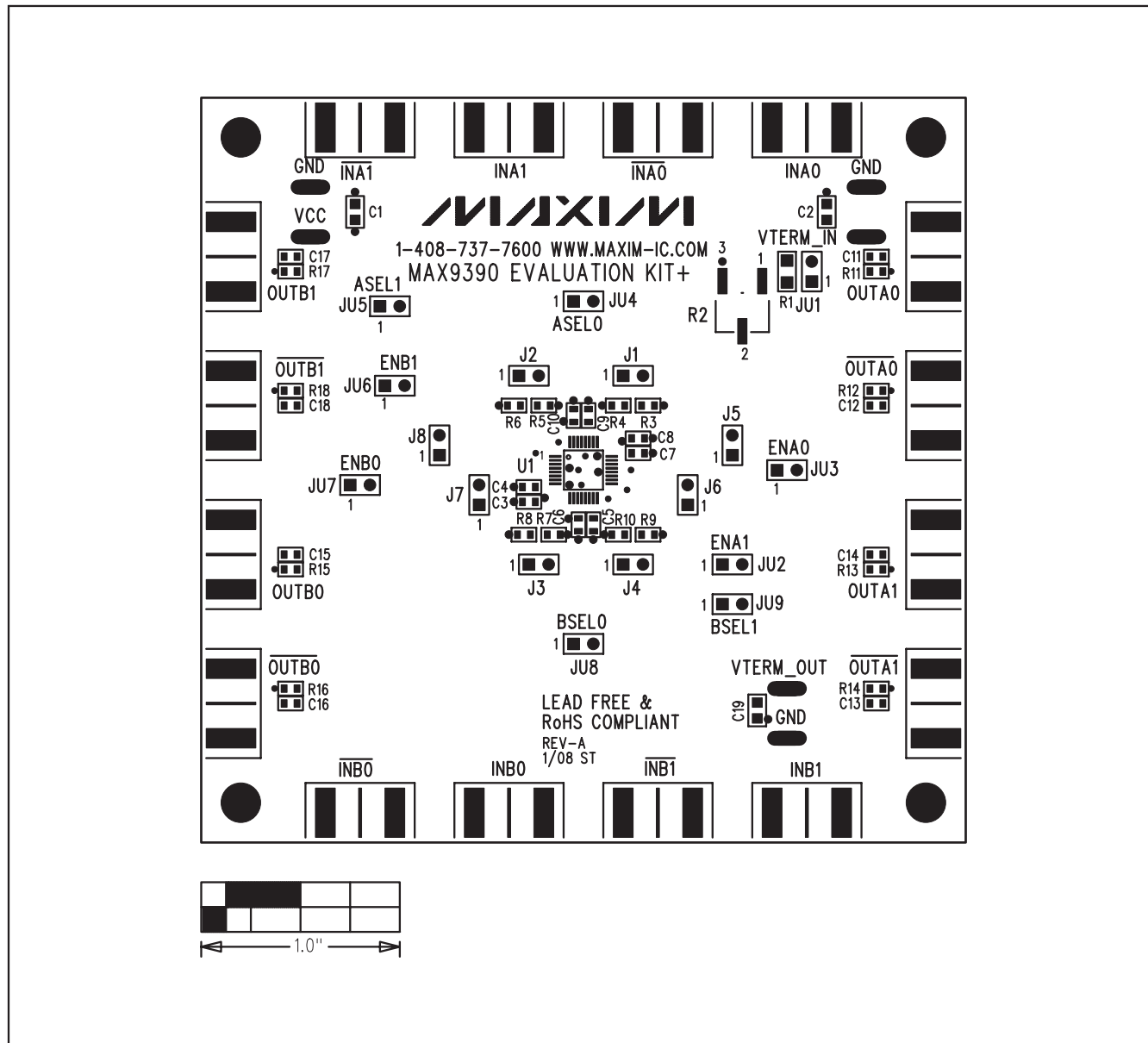

Figure 2. MAX9390 EV Kit Component Placement Guide—Component Side

MAX9390 Evaluation Kit

Evaluates: MAX9390/MAX9391

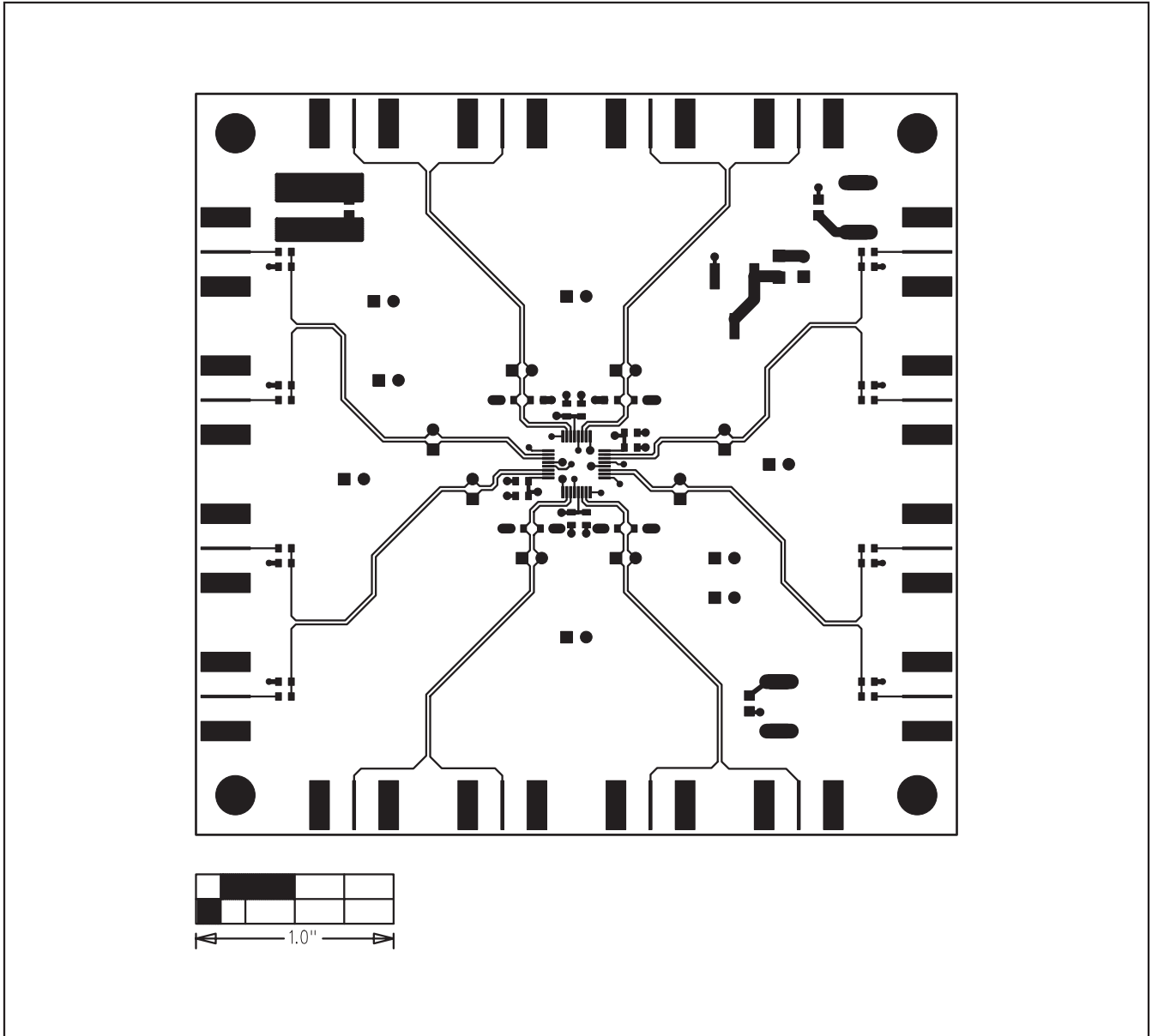

Figure 3. MAX9390 EV Kit PCB Layout—Component Side

MAX9390 Evaluation Kit

Evaluates: MAX9390/MAX9391

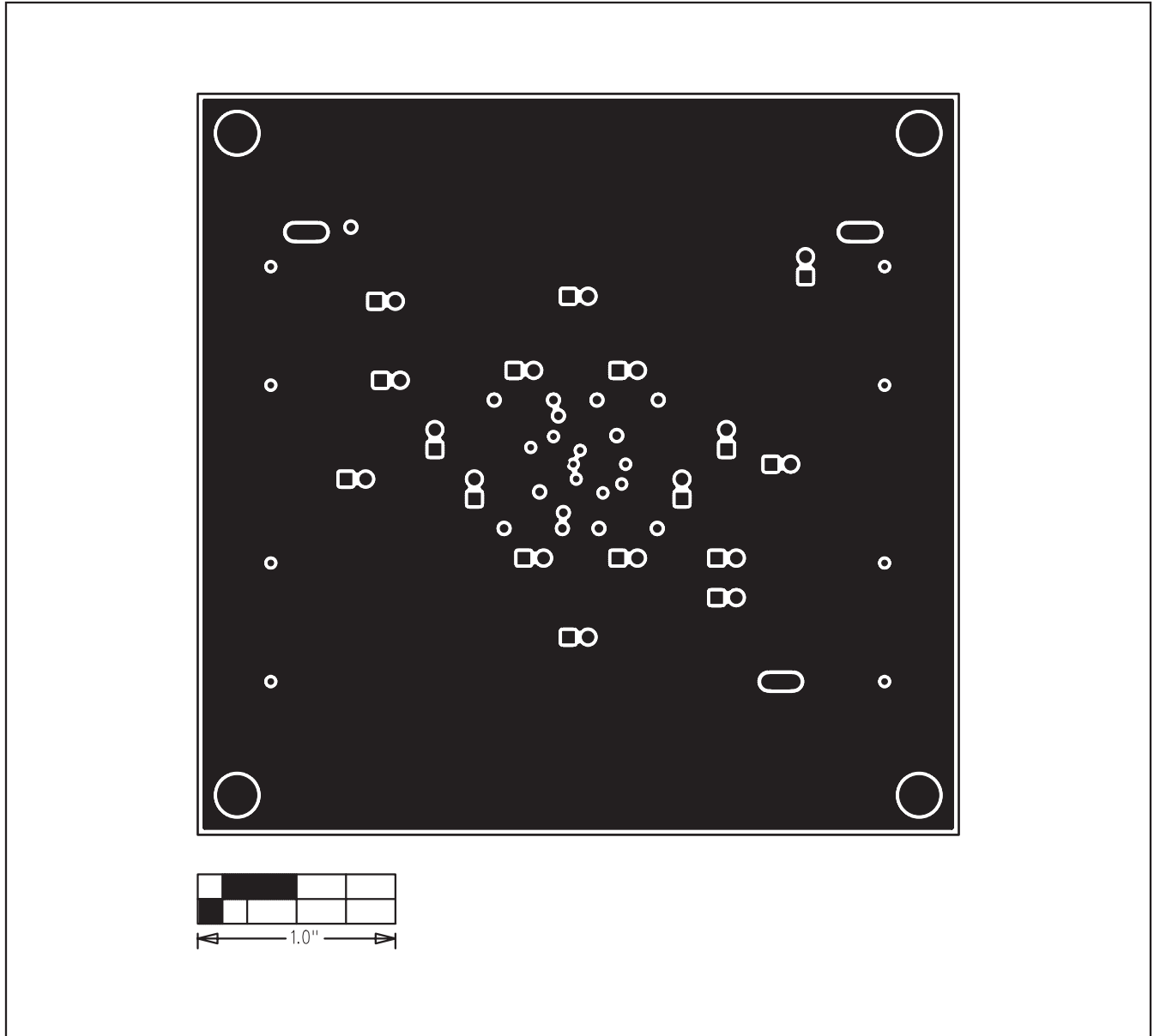

Figure 4. MAX9390 EV Kit PCB Layout—GND

MAX9390 Evaluation Kit

Evaluates: MAX9390/MAX9391

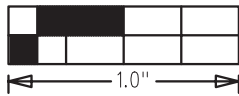
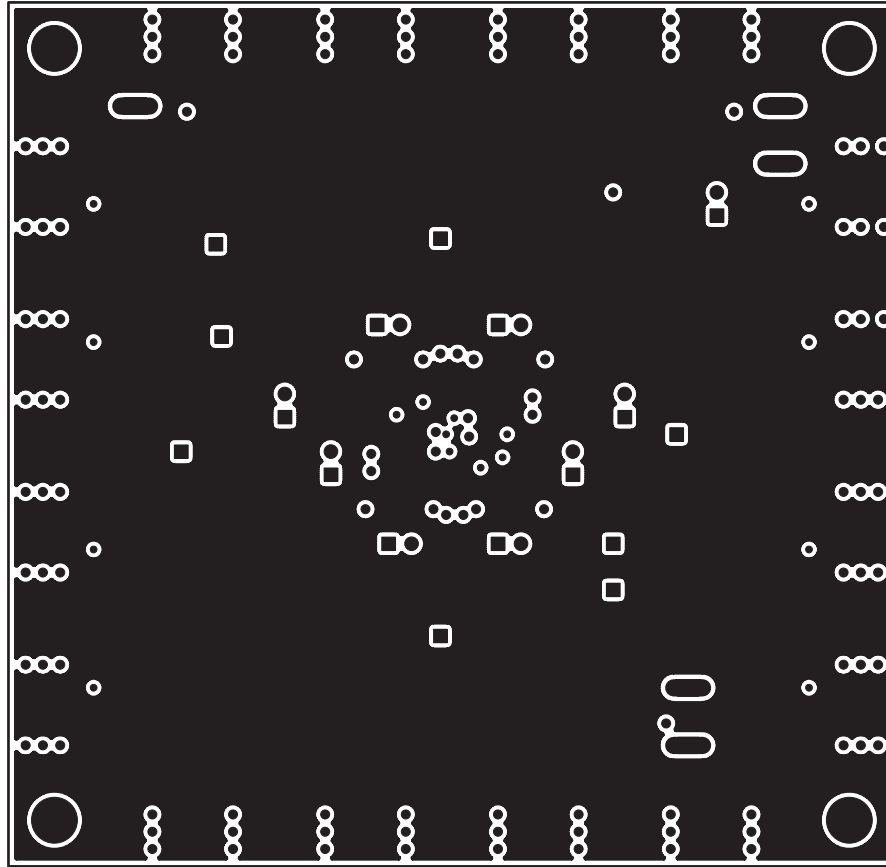

Figure 5. MAX9390 EV Kit PCB Layout—Power

MAX9390 Evaluation Kit

Evaluates: MAX9390/MAX9391

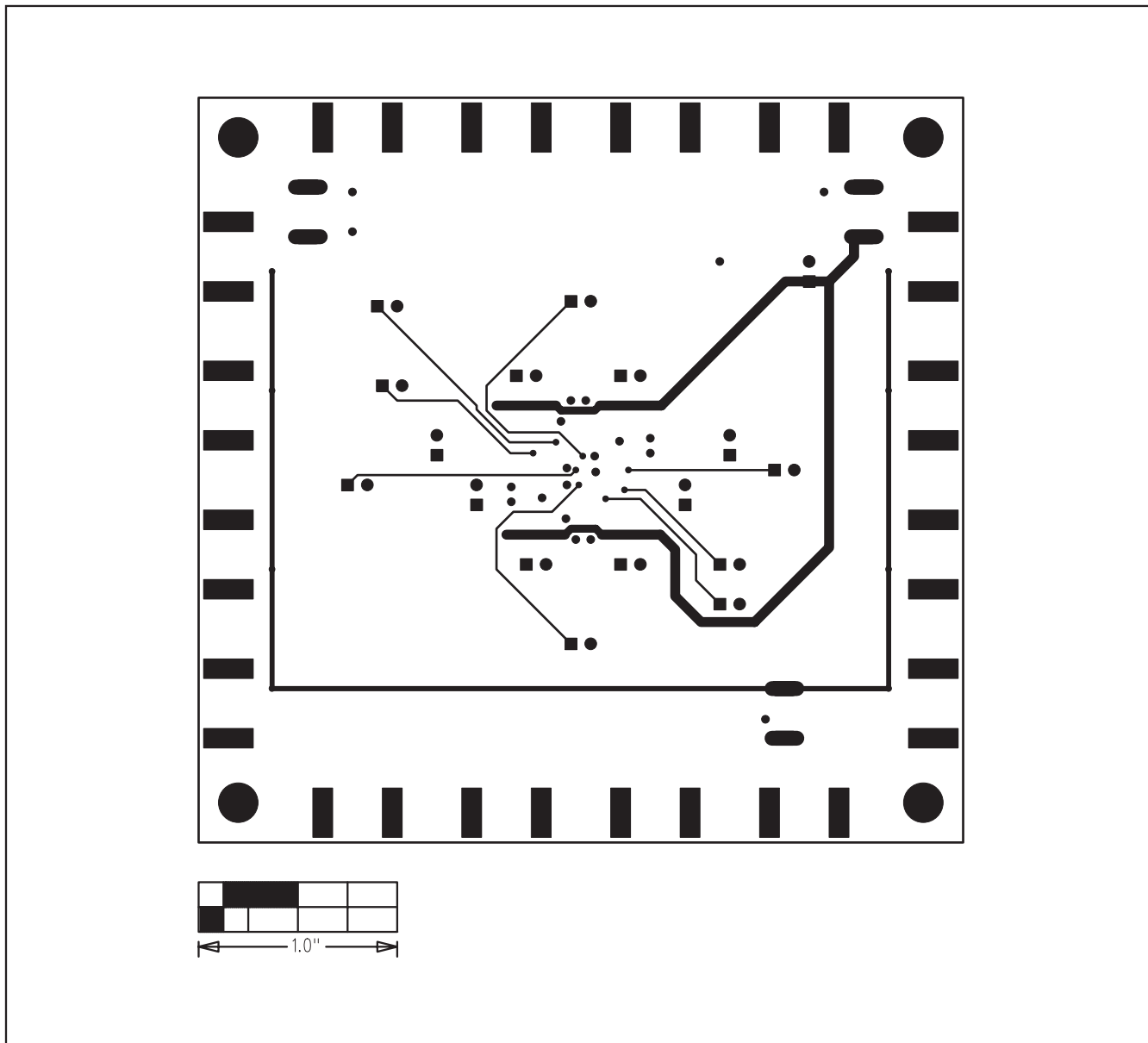

Figure 6. MAX9390 EV Kit PCB Layout—Solder Side

Maxim cannot assume responsibility for use of any circuitry other than circuitry entirely embodied in a Maxim product. No circuit patent licenses are implied. Maxim reserves the right to change the circuitry and specifications without notice at any time.

10 **Maxim Integrated Products, 120 San Gabriel Drive, Sunnyvale, CA 94086 408-737-7600**

© 2008 Maxim Integrated Products

MAXIM is a registered trademark of Maxim Integrated Products, Inc.